

**MESSERSCHMIT BF-109. E**  
étude et réalisation : Frantz LALLEMAND  
PLAN GRATUIT MRA A 749

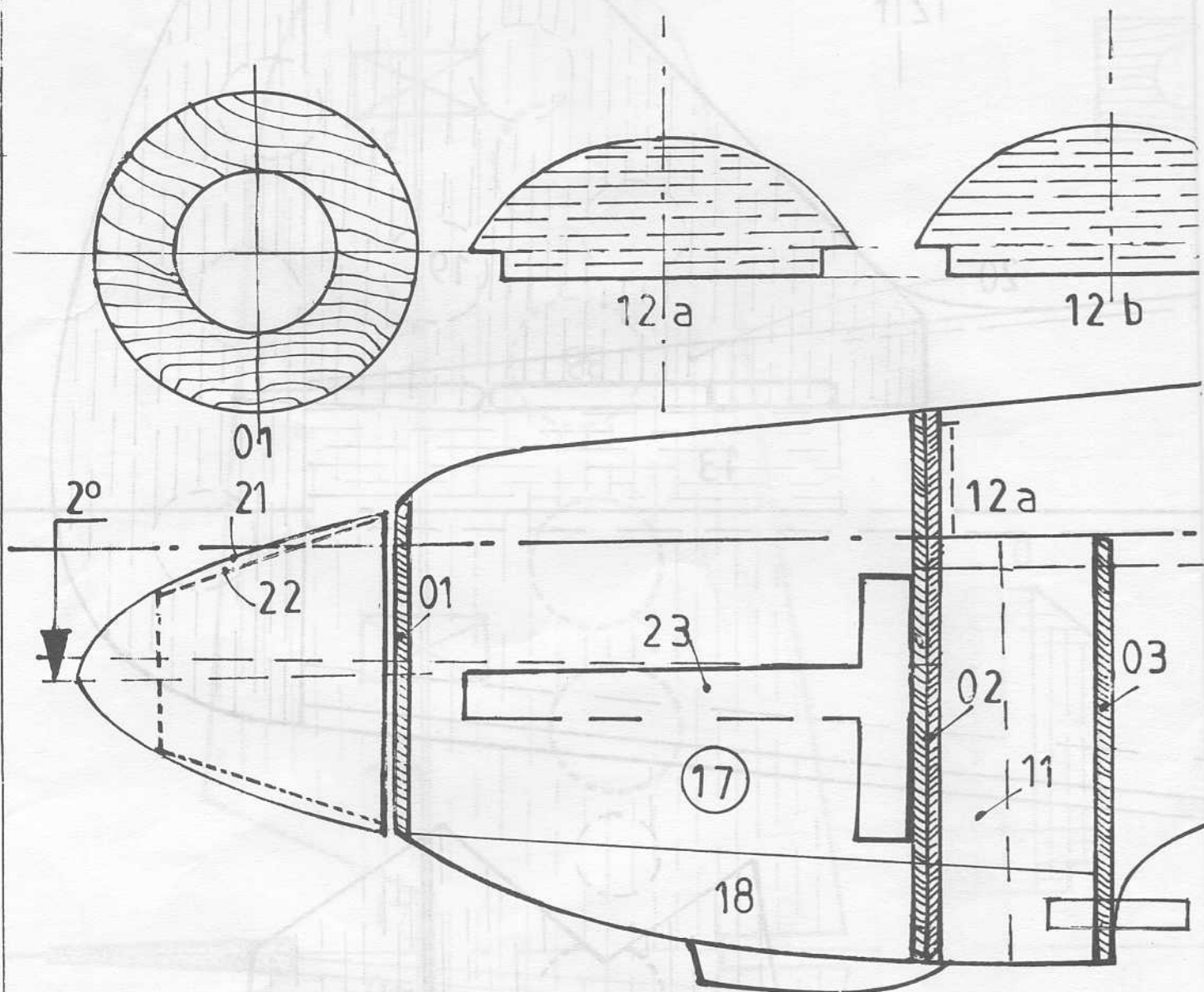

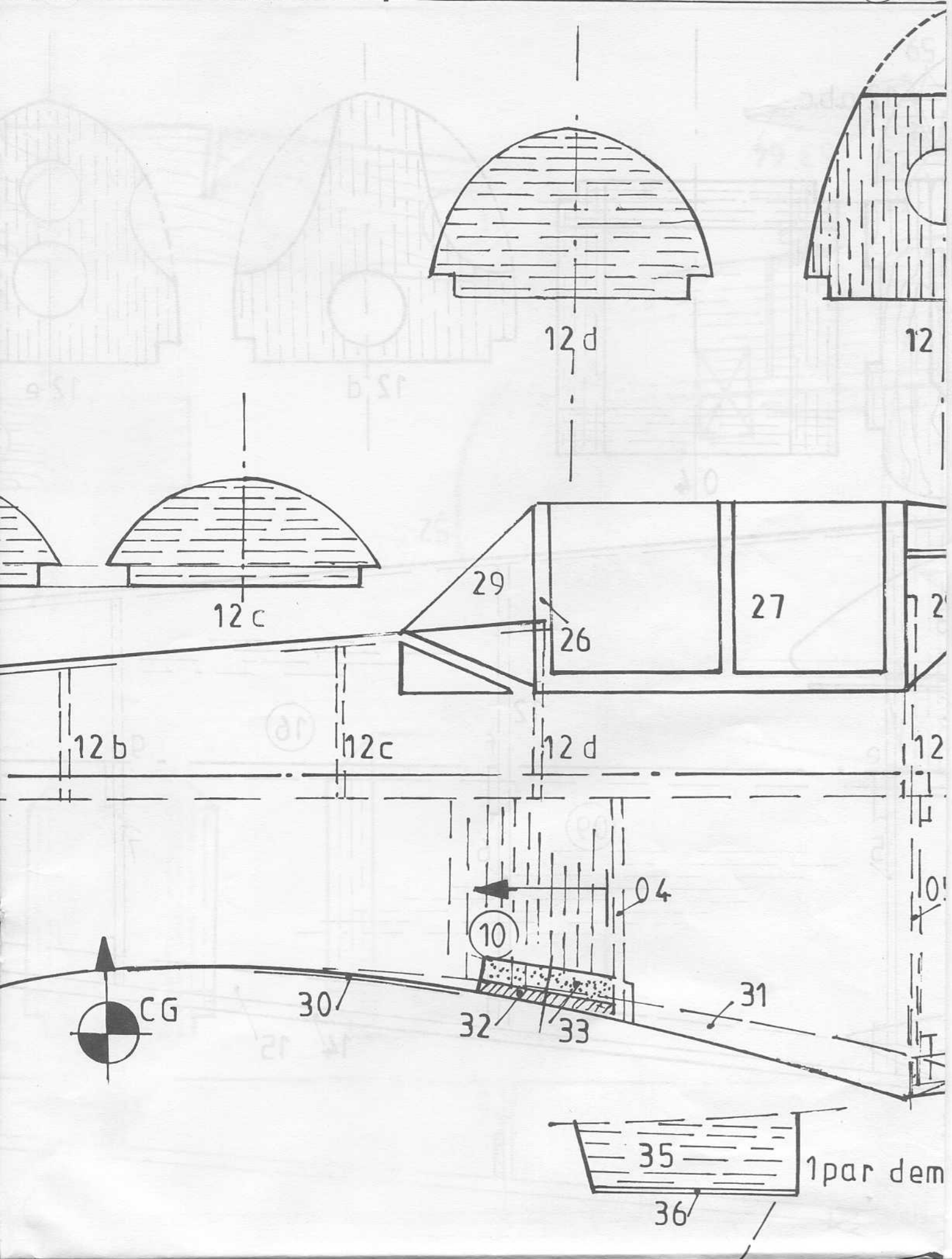

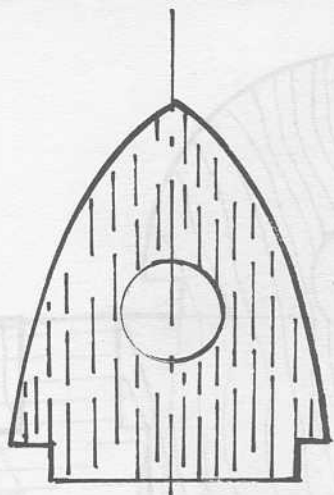

12 f

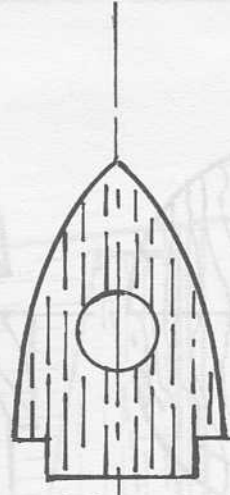

12 g

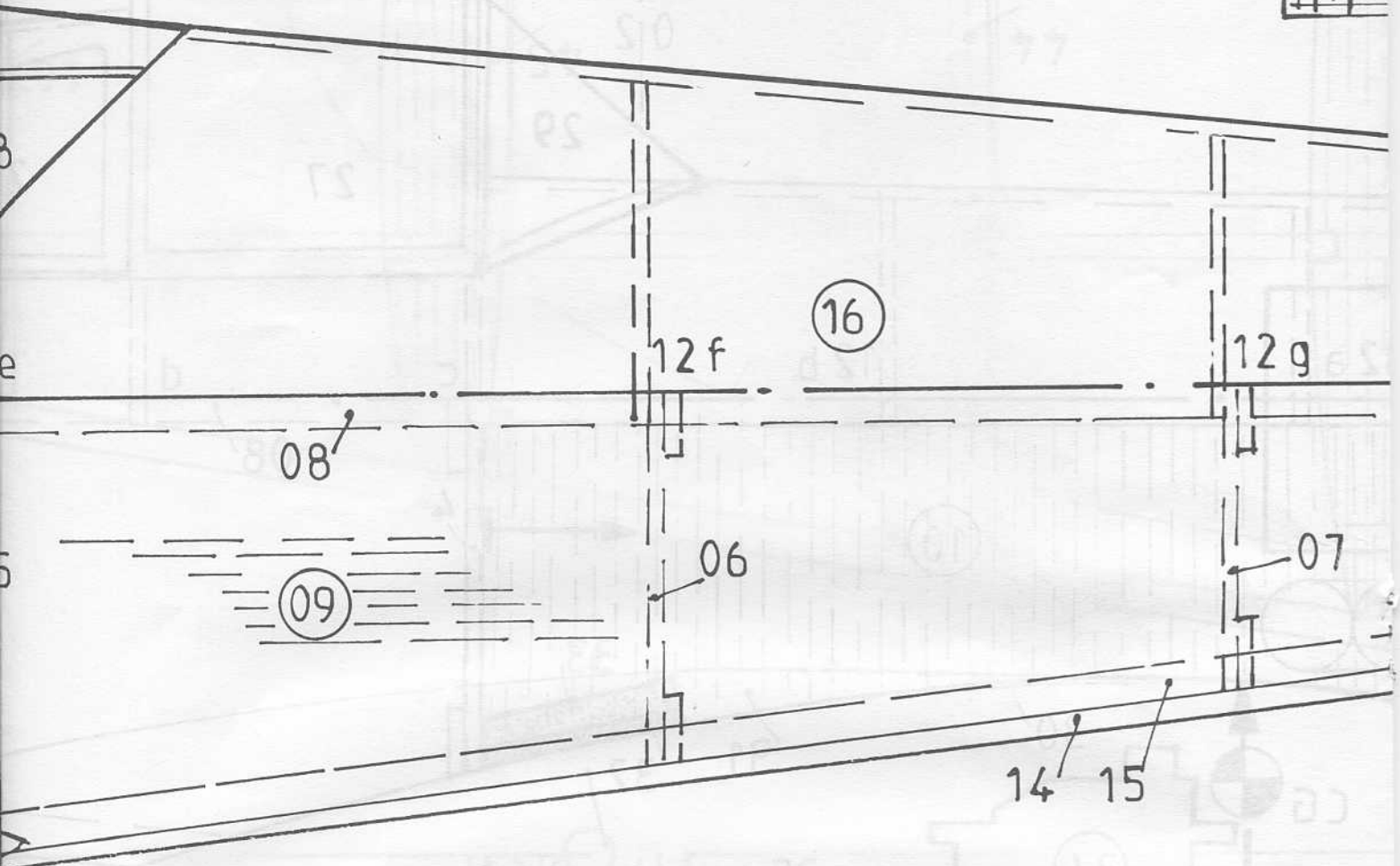

i-aile

DEWOITINE D-520  
étude et réalisation : Francis LALLEMAND  
PLAN GRATUIT MRA A 749

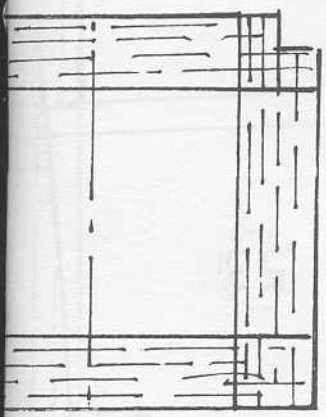

0/4

20

19

13

bd 5x2

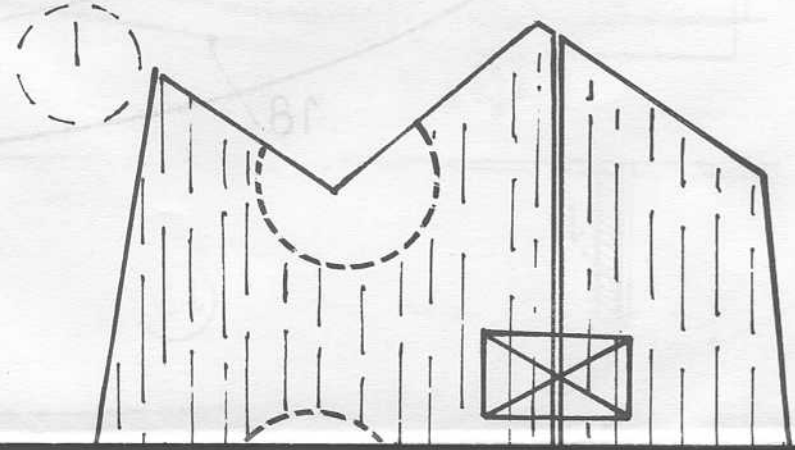

09

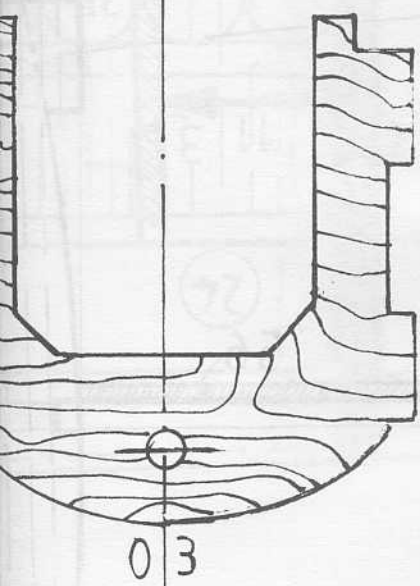
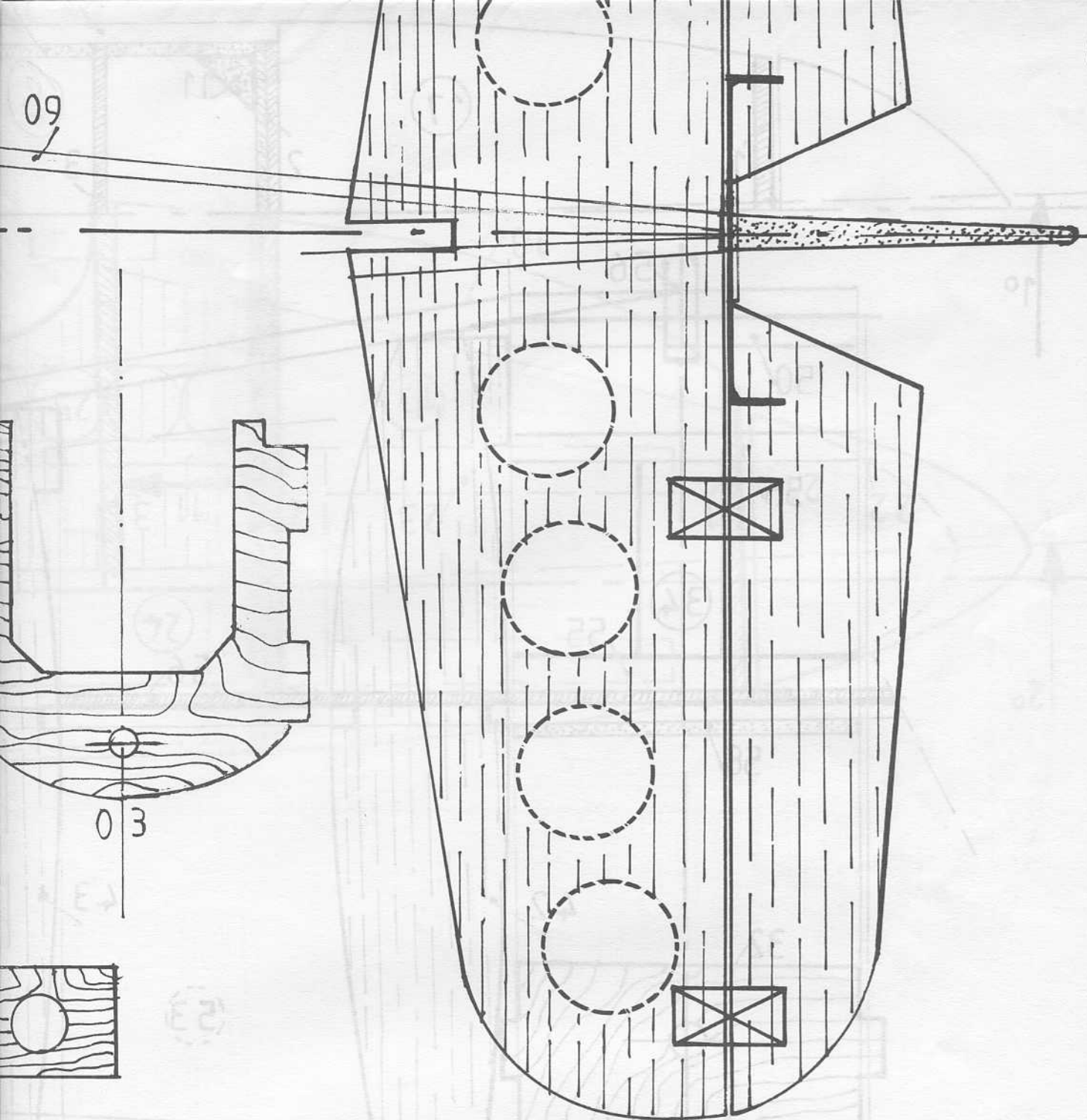

03

