

Coupe A-A (propulsion installée).

Zones achrées obliques: ouvrir.

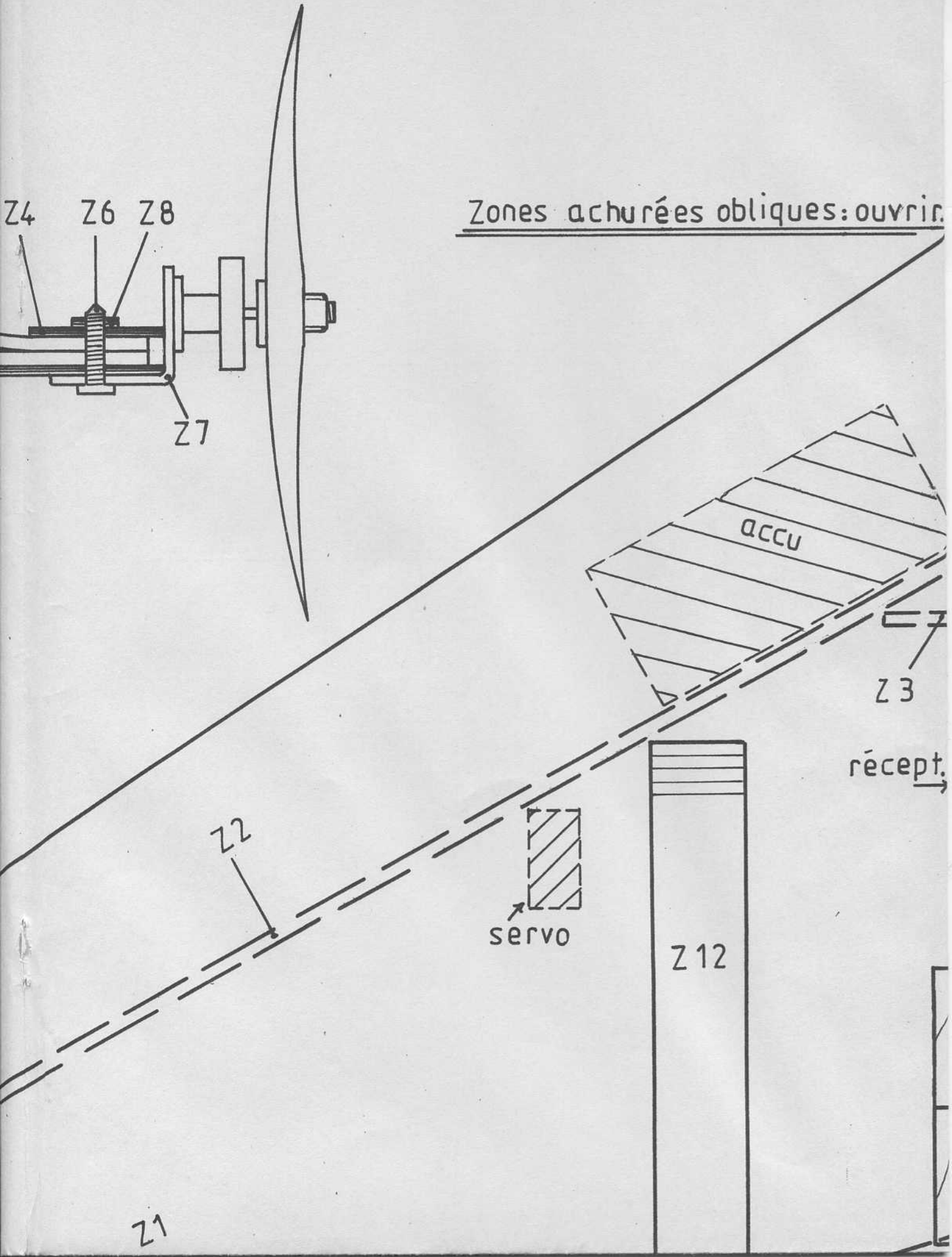

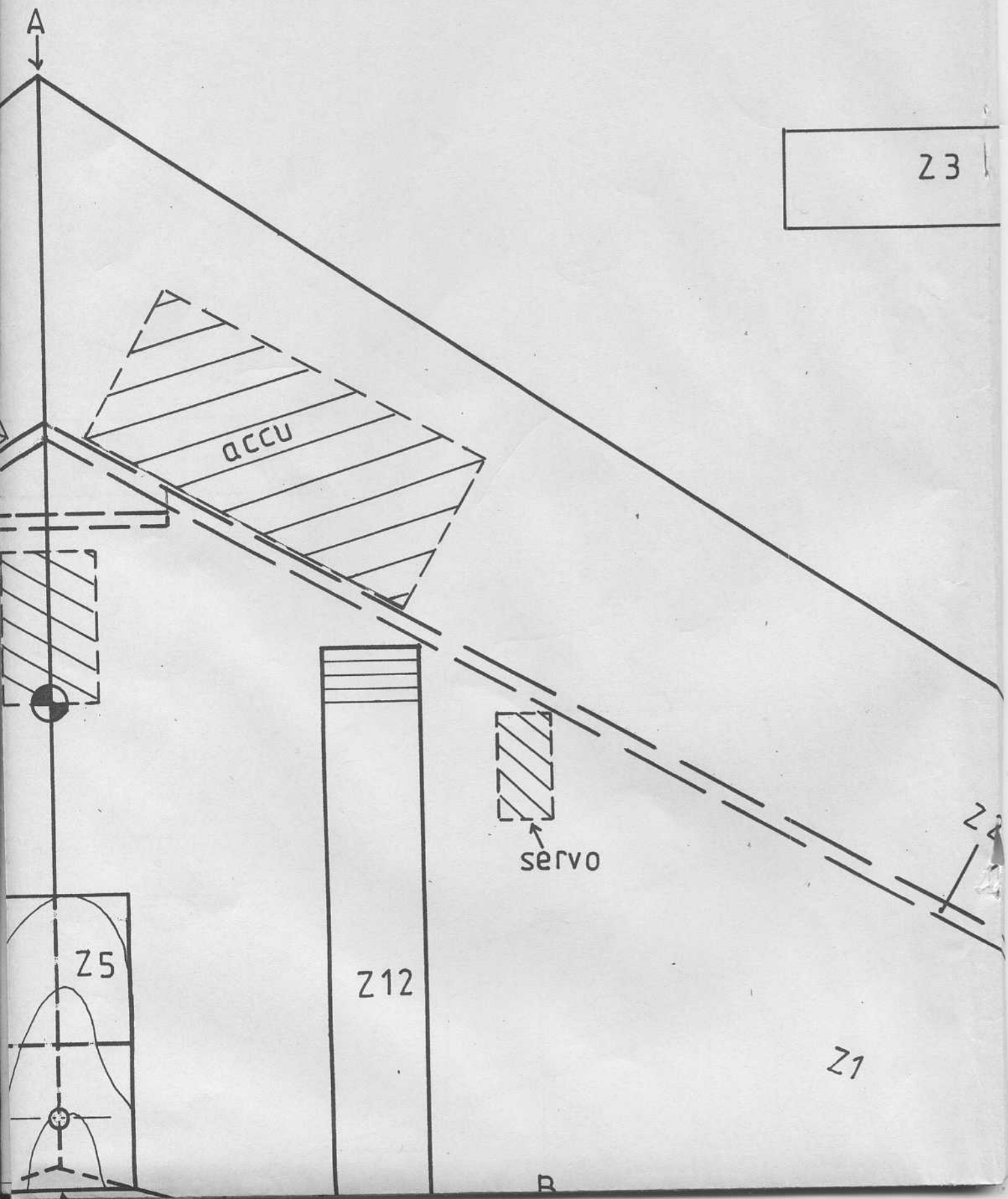

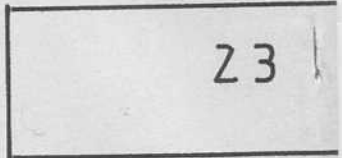
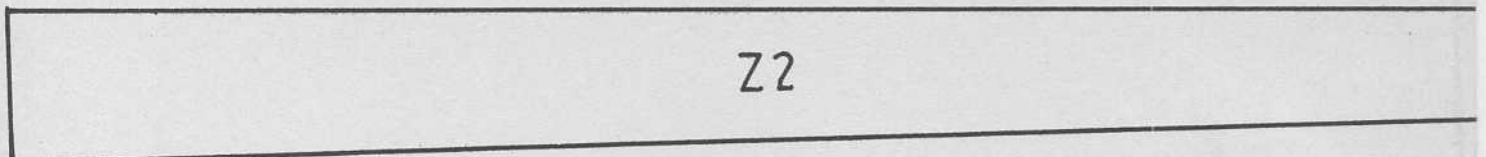
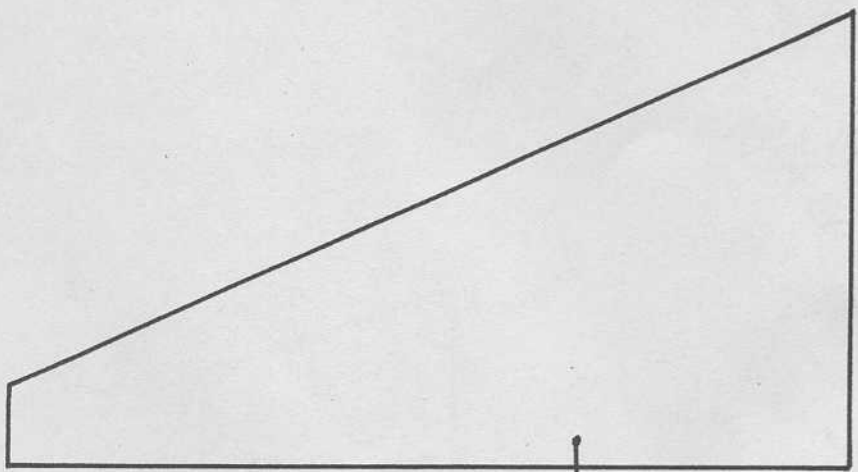
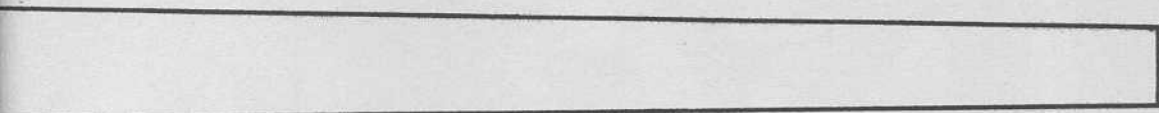

Z11

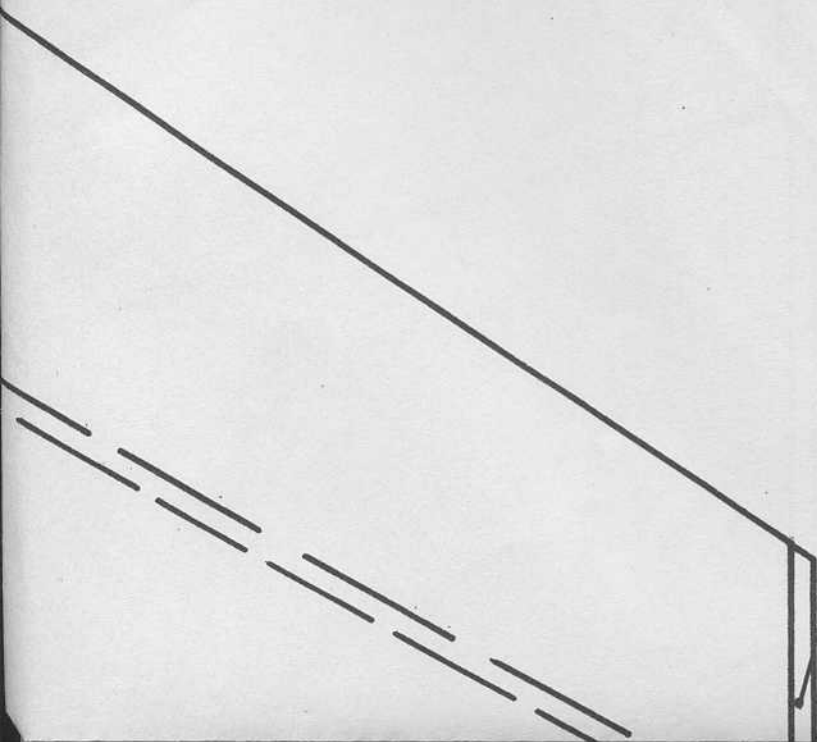

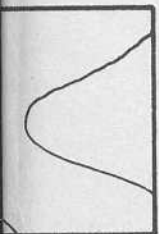
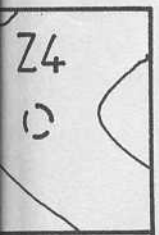
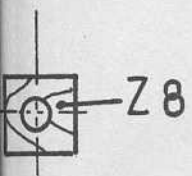

Dessin: Th. SOUJIN. Avr. 2009.

x-Aiile

A

née côté intrados.

s groupe de propulsion).

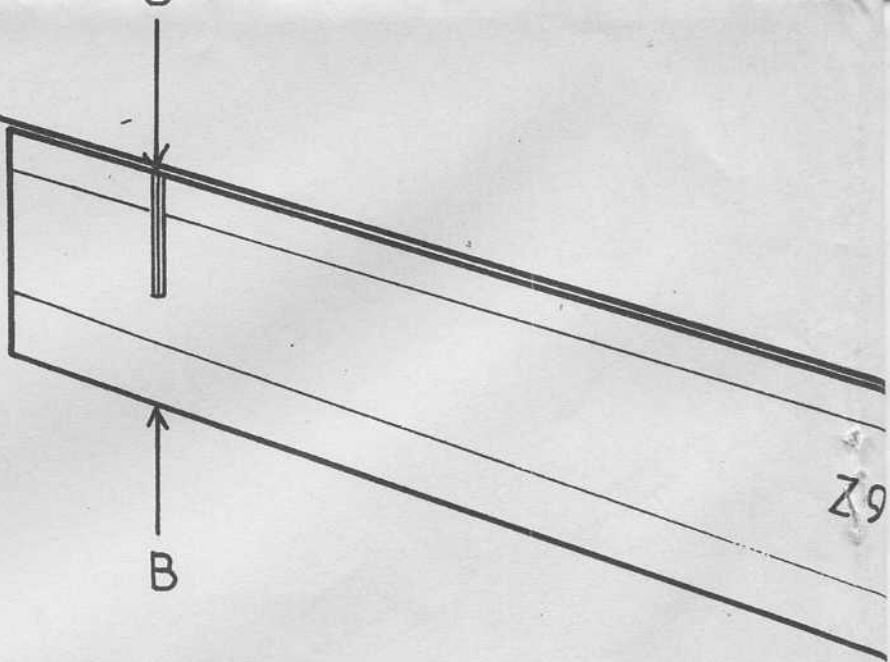

B

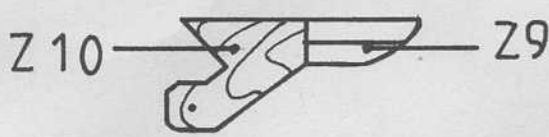

Coupe B-B.

600 mm.

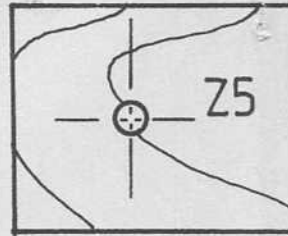
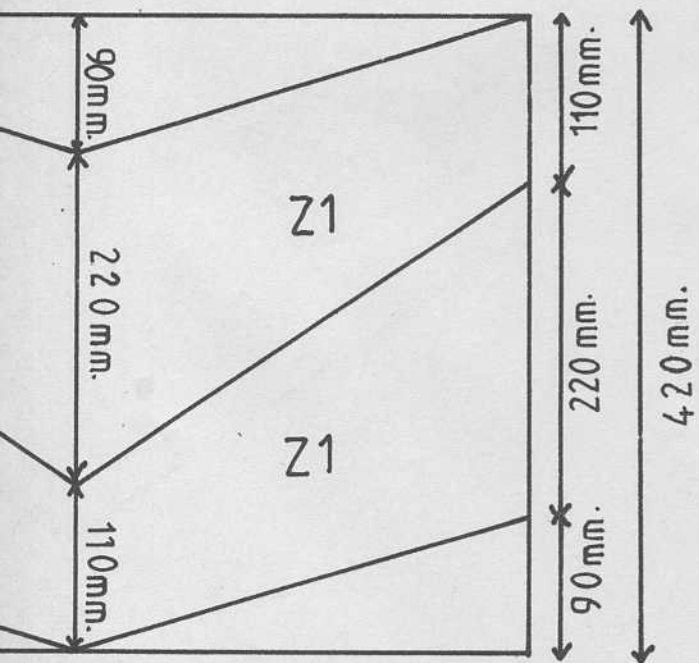

c.1.

. Conception : Xavier VERCKEN.

6

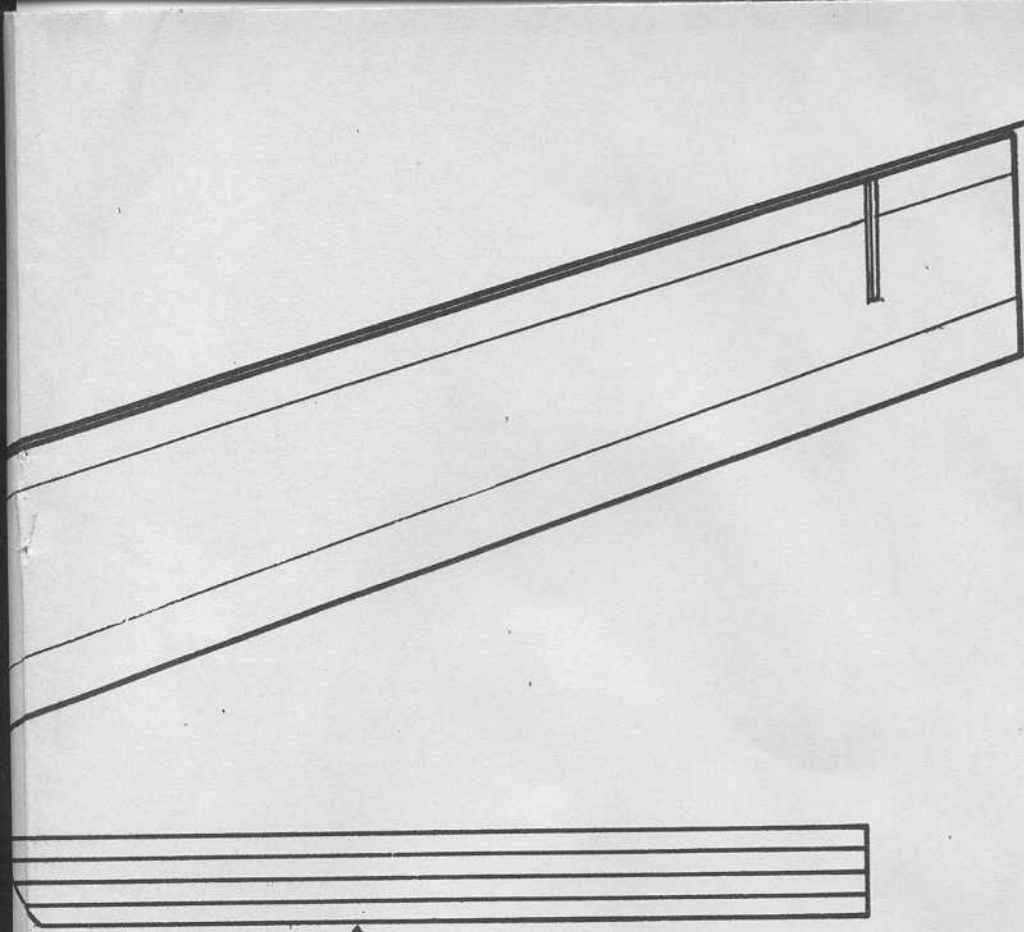

Aile dessinée

(horizontale)

↑
Z 12 (Vue de coté).

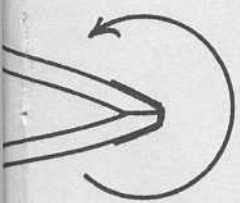
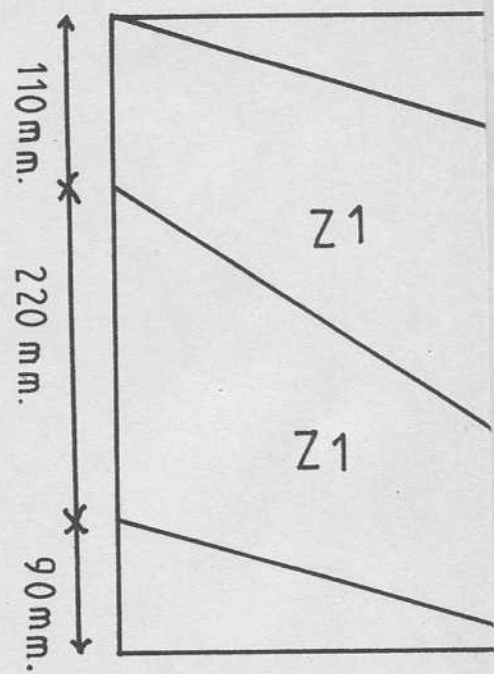

S

(7)

211

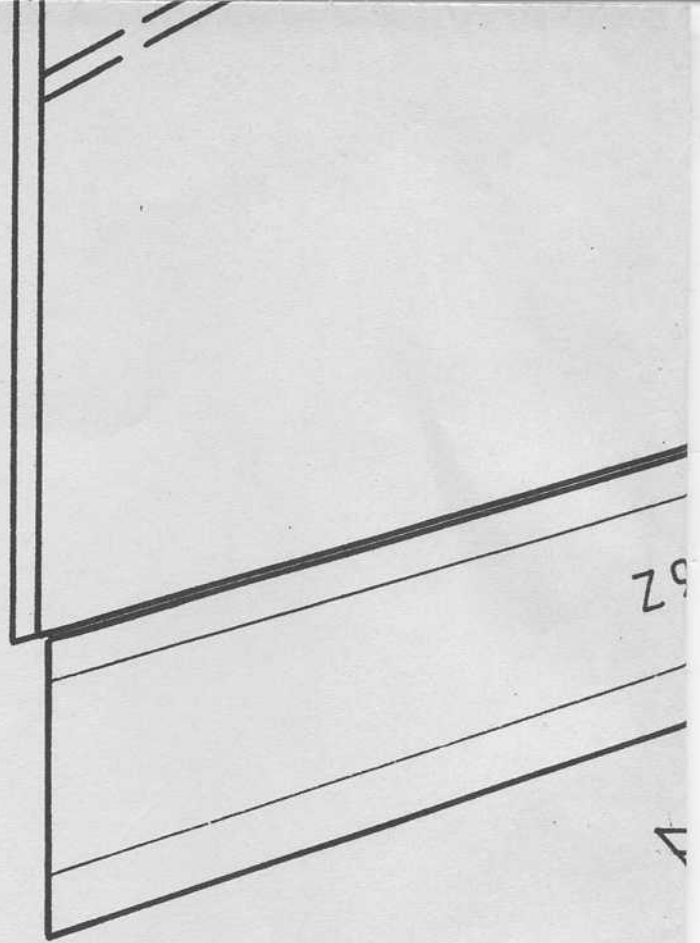

29

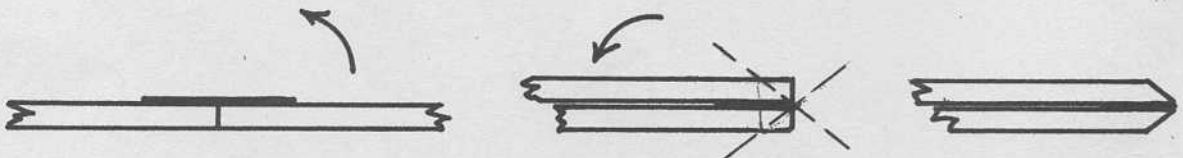

Sc.2.

